

XTOOL

Screen Printer

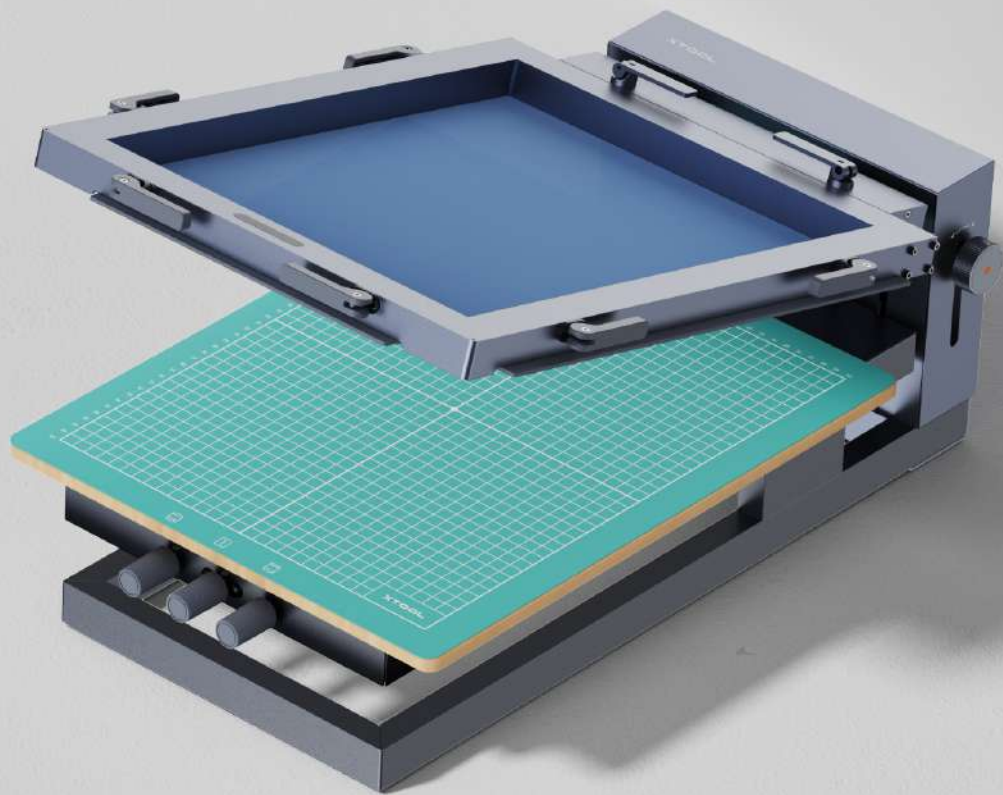

User Manual

Statement ----- 01

List of items ----- 01

Meet your xTool Screen Printer ----- 03

Use your xTool Screen Printer ----- 04

Maintenance ----- 12

After-sales services ----- 12

Statement

Thank you for choosing xTool products!

If you use the product for the first time, read carefully all the accompanying materials of the product to improve your experience with it. If you do not use the product according to the instructions and requirements of the Manual, or mis-operate the product due to misunderstanding, etc., the Company shall bear no responsibility for any loss resulting therefrom.

The Company has collated the content of the Manual rigorously and carefully, but errors or omissions may remain.

The Company is committed to continuously improving product functions and service quality, and therefore reserves the right to change any product or software described in the Manual and the content of the Manual at any time.

The Manual is intended to help you use the product properly and does not include any description of hardware and software configuration. For product configuration, refer to the related contract (if any) and packing list, or consult your distributor. Images in the Manual are for reference only and the actual product may vary.

Protected by copyright laws and regulations, the Manual shall not be reproduced or transcribed in any way, or be transmitted on any wired or wireless network in any manner, or be translated into any language, or be modified in any way, such as content, image, or layout modification, without the prior written authorization of the Company.

The Company is committed to continuously improving the product and related materials. The product and the Manual are subject to change, and updates can be found at xtool.com.

List of items

Remove the cardboards from the packaging box. You can print on the back of the cardboards.

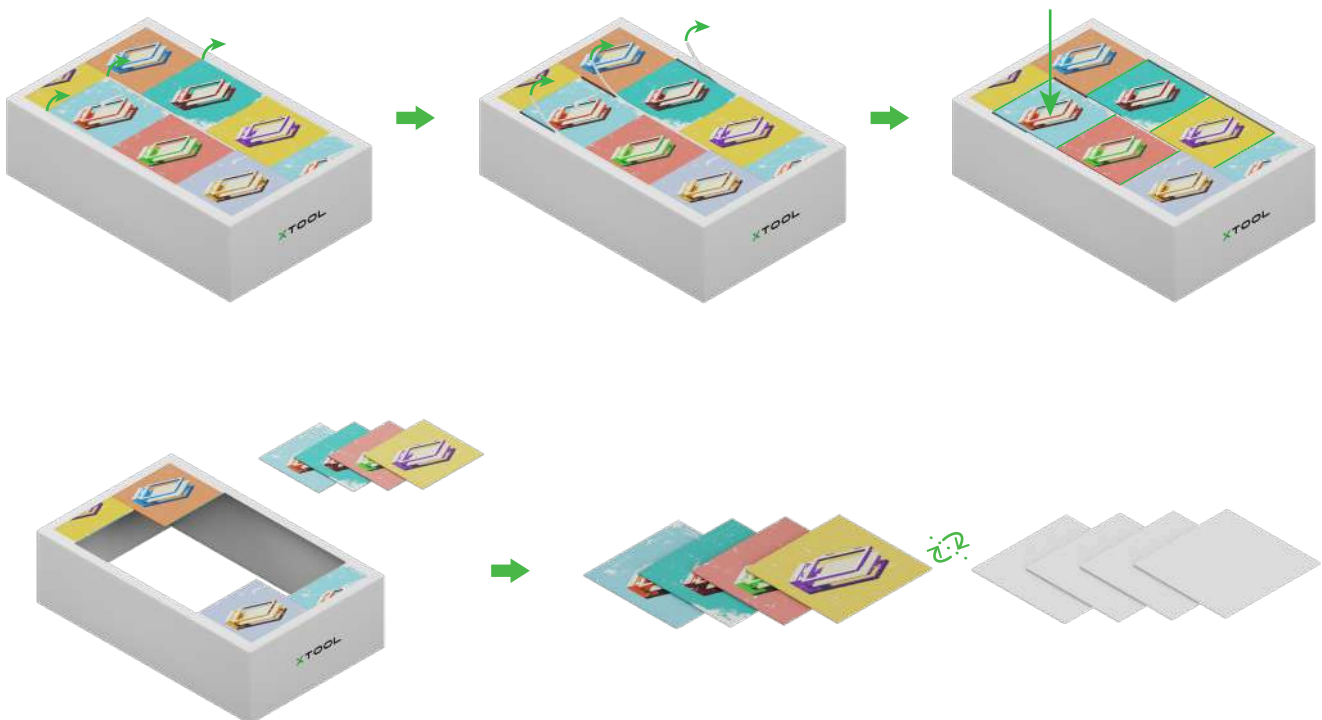

Basic kit (small frame)



xTool Screen Printer



Magnetic board



Small frame
9" x 12"



Fixing pin

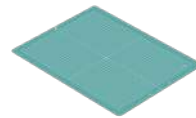

Cutting mat



Small squeegee
8.2" x 4.8"



Storage box

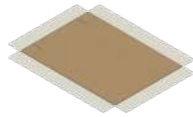

Small screen
9" x 12"



Ink spatula
8" x 0.8"



Water-based ink



Oil painting
canvas

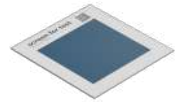

Screen for test



User manual



FAQs

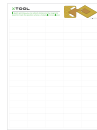

Sticker



Screen &
frame card



Accessory &
material card

Basic kit



xTool Screen Printer



Magnetic board



Frame 11.5" x 16"



Fixing pin

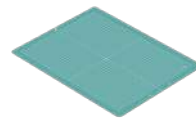

Cutting mat



Squeegee
10.7" x 4.8"



Storage box

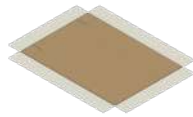

Screen 11.5" x 16"



Ink spatula
8" x 0.8"



Water-based ink



Oil painting
canvas

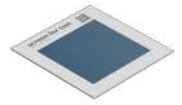

Screen for test



User manual



FAQs



Sticker



Screen &
frame card



Accessory &
material card

Meet your xTool Screen Printer

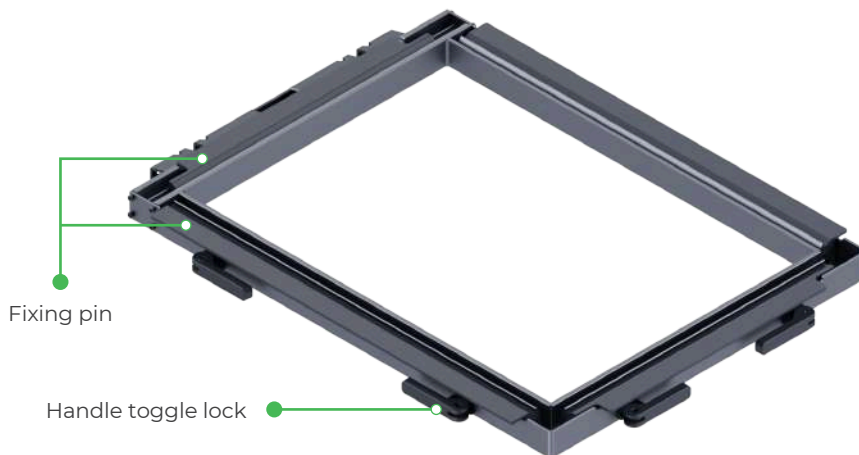
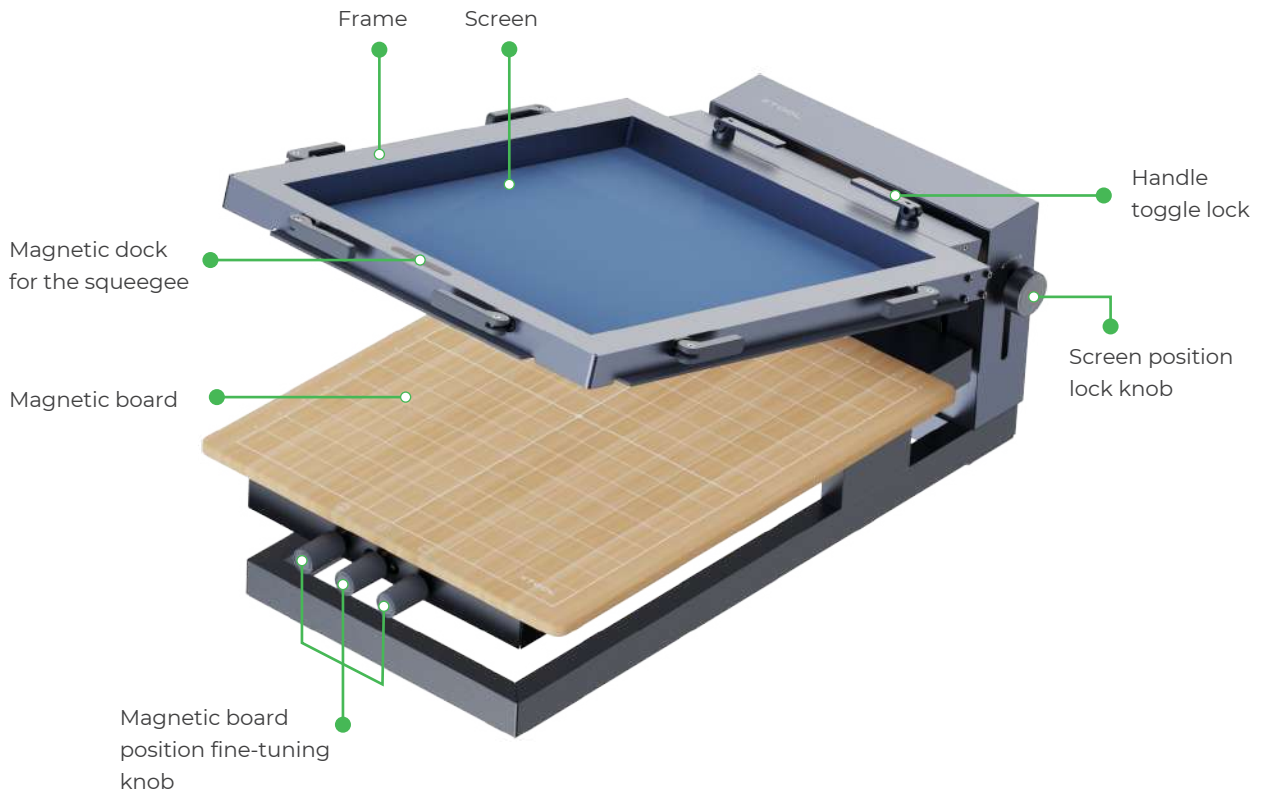

Use your xTool Screen Printer

1. Mount the screen on the frame

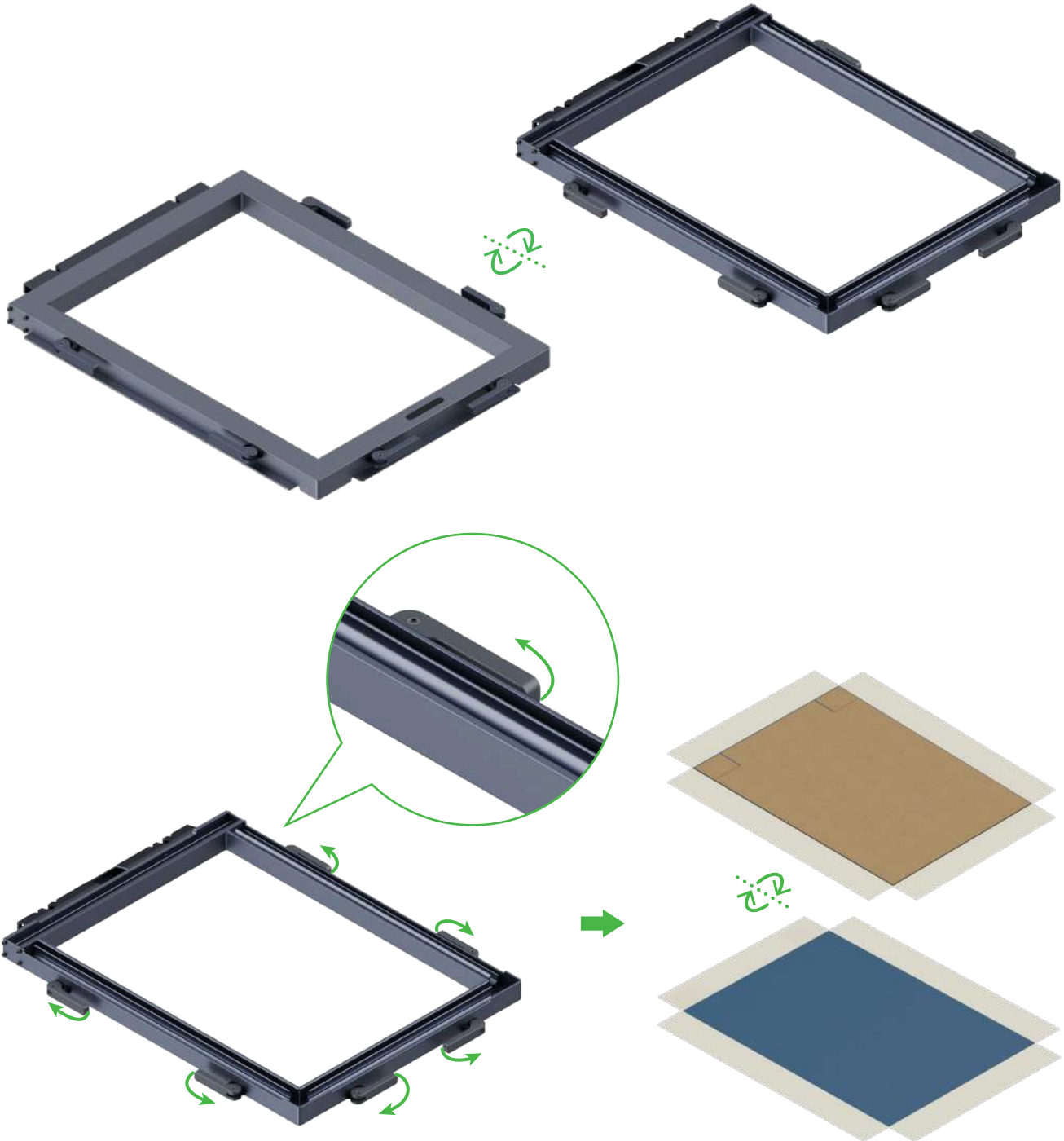
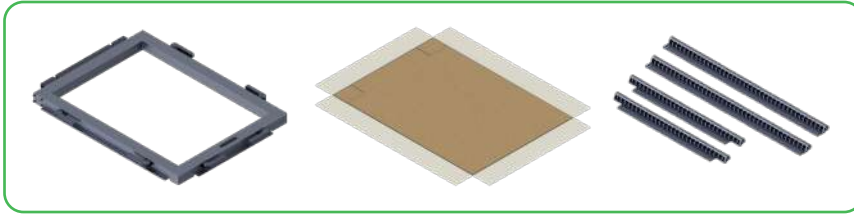

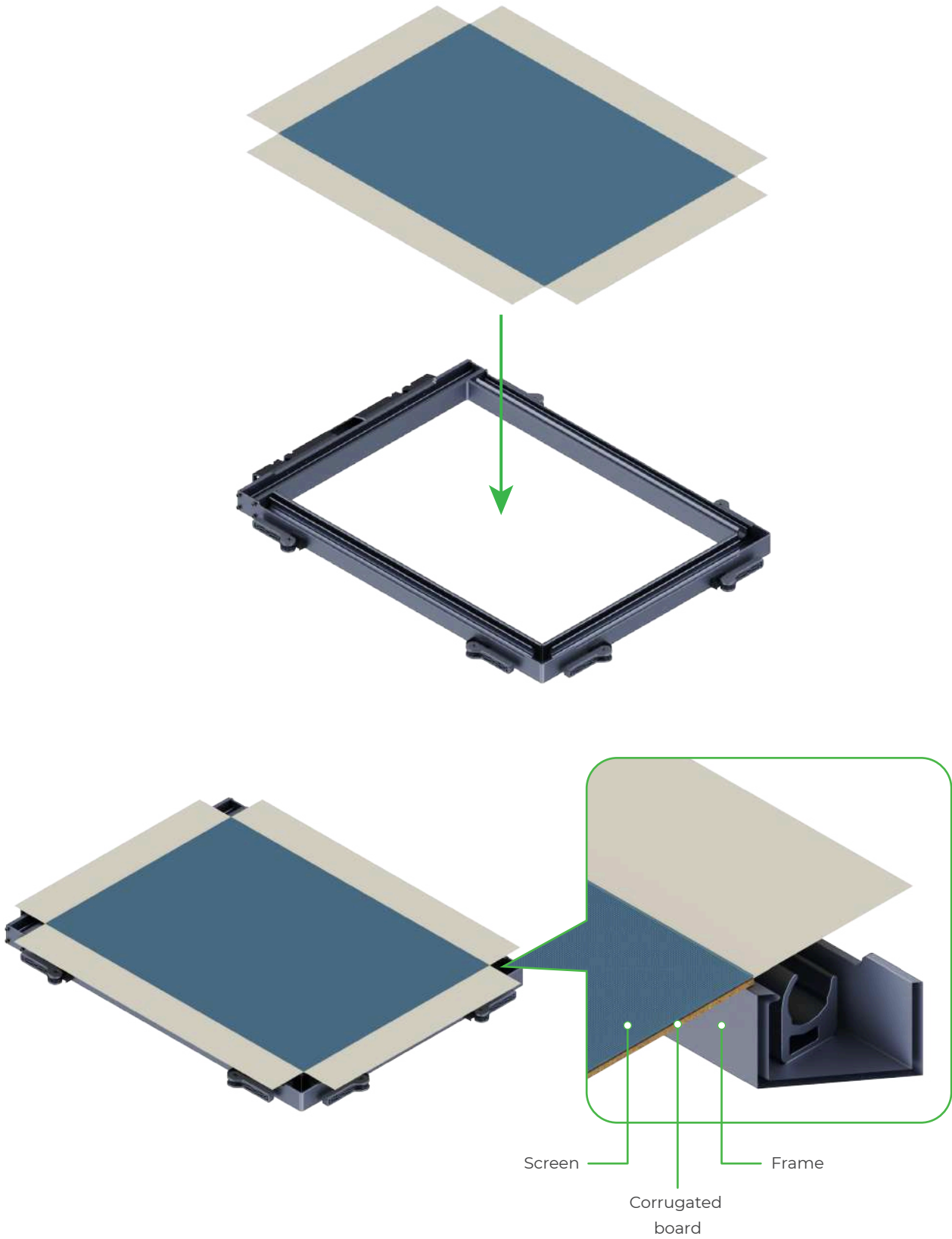

Ensure that the corrugated board is placed fully into the frame and the screen is on top of the frame. Do not press the screen when mounting it.

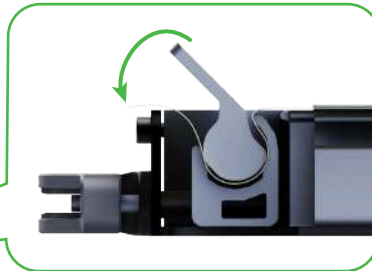
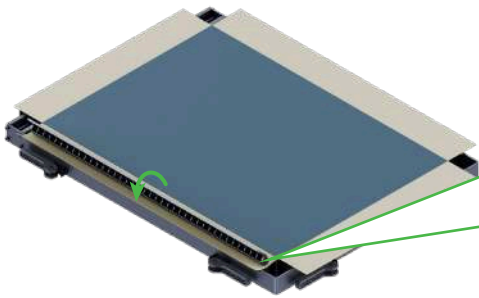
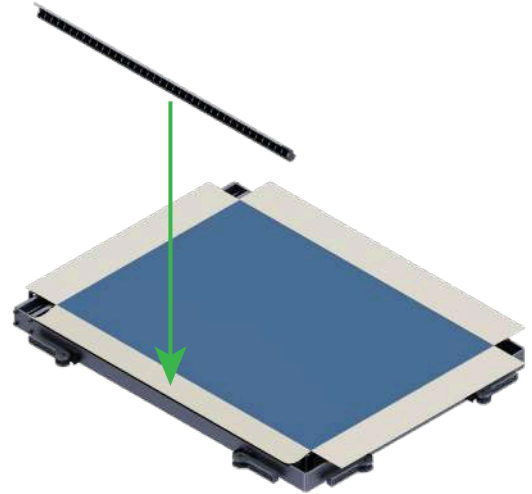
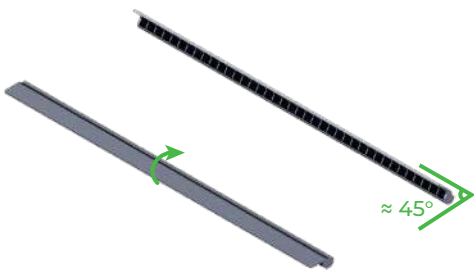
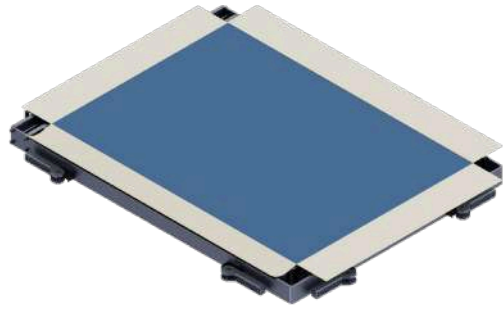
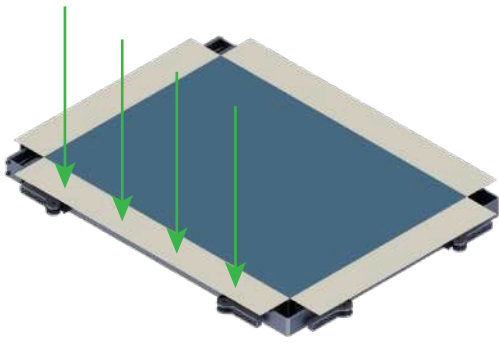

Position the fixing pin properly before you rotate it to secure it.

Fit the other three fixing pins in the same way.

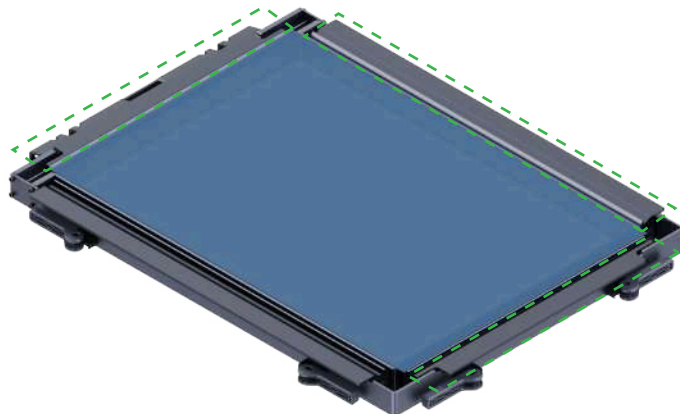

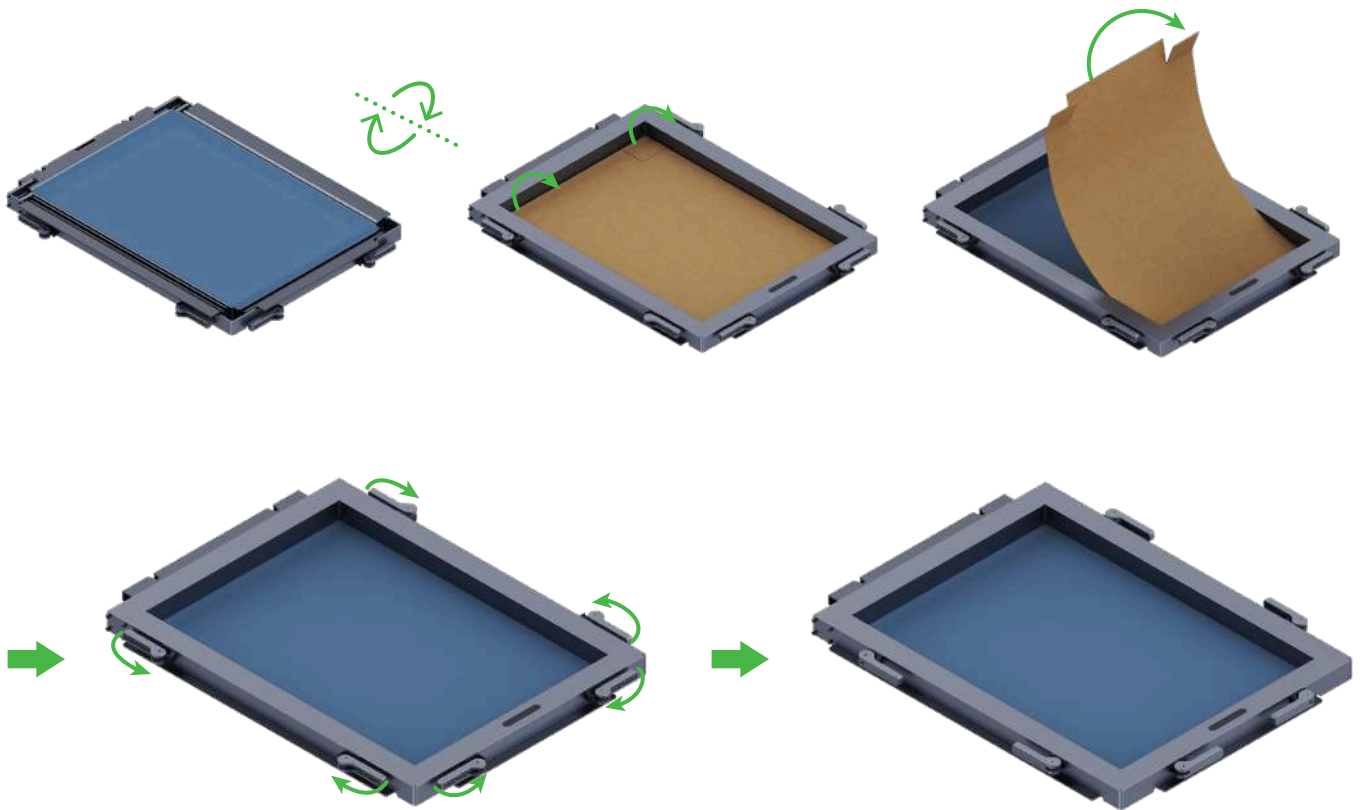

If any fixing pin falls after you turn the frame over, fit it into the frame again. If the screen is not mounted flat on the frame, mount it again.

2. Prepare the screen

You can use a laser machine to prepare your screen easily.

- (1) Design or import a pattern on the software that works with your laser machine.
- (2) Flip the frame and screen over so the back side faces up.



(3) Place the screen, which has been mounted on the frame, in the processing area of the laser machine to engrave your design on it. For details, visit support.xtool.com/product/29.

3. Print your design

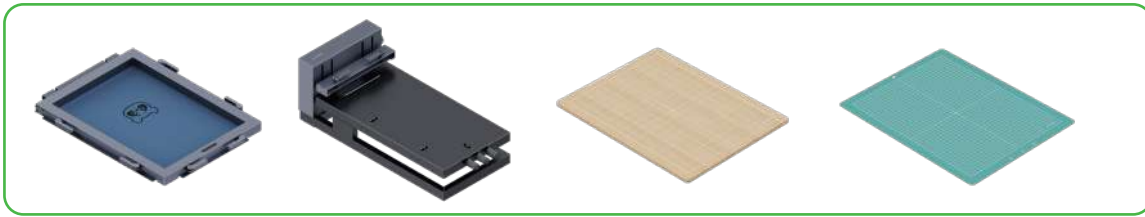

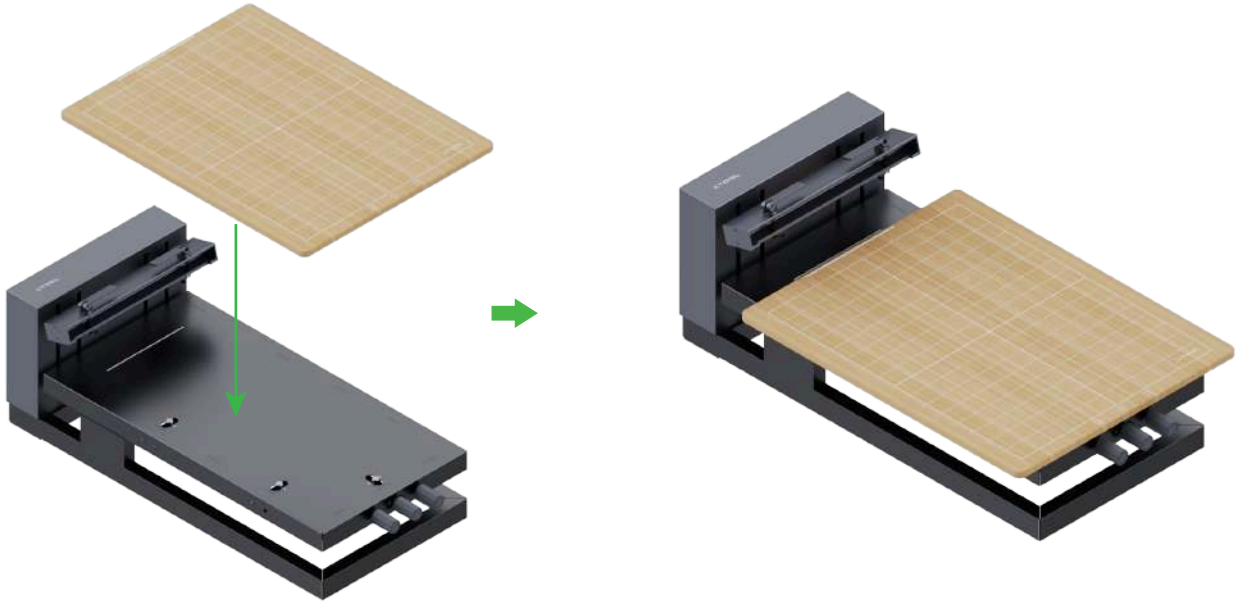

After you mount the magnetic board on the screen printer, you can fine-tune the position of the magnetic board by using the three position fine-tuning knobs. You can also make a magnetic board by yourself as needed.

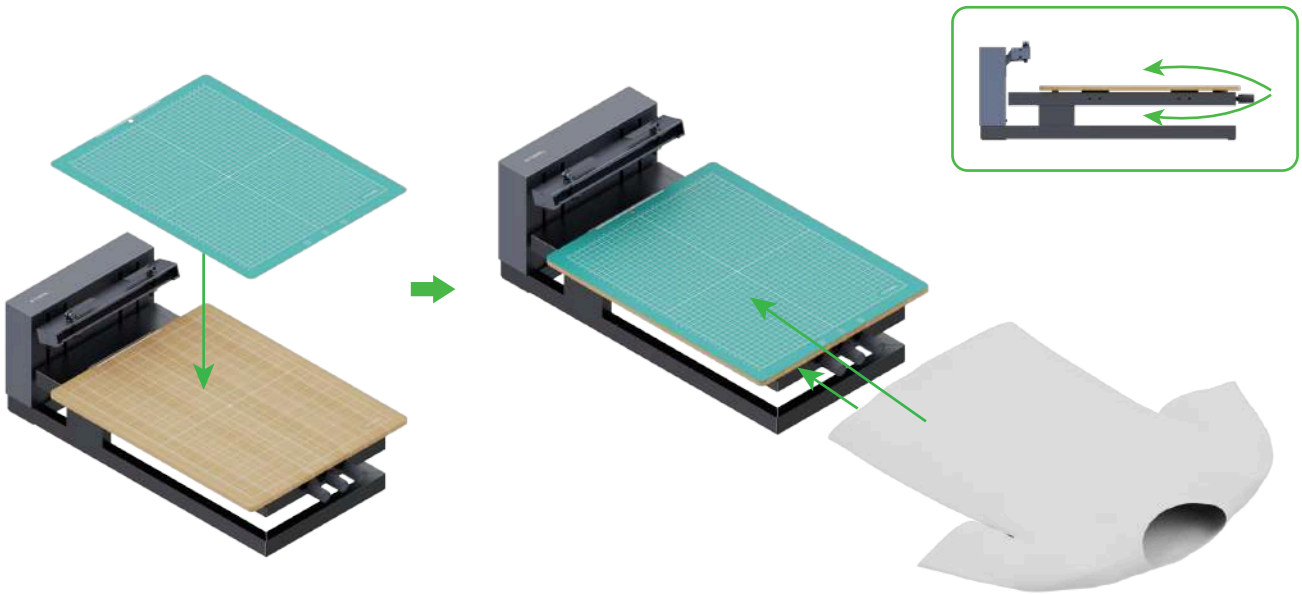

You can determine whether to use the cutting mat based on the texture of your material.



Ensure that the area to be printed on the material is flat without wrinkles.

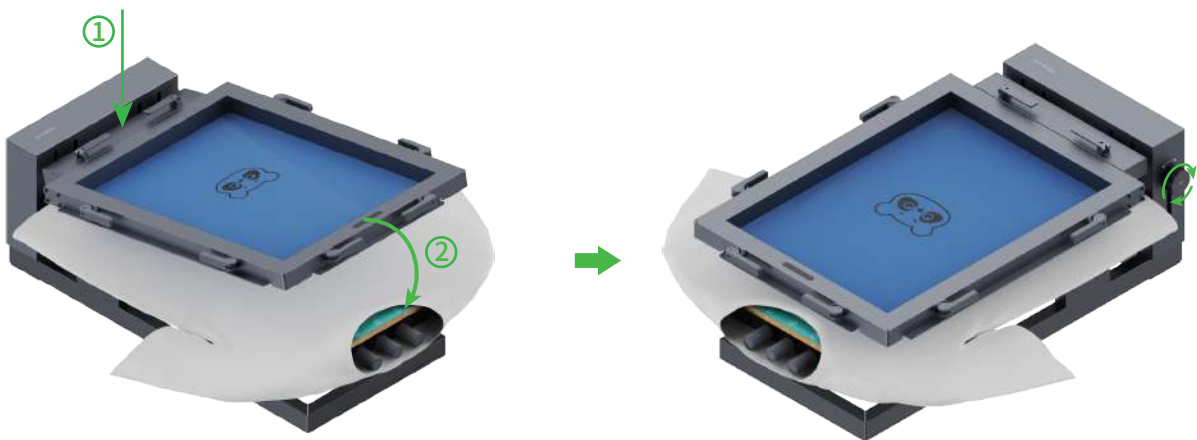
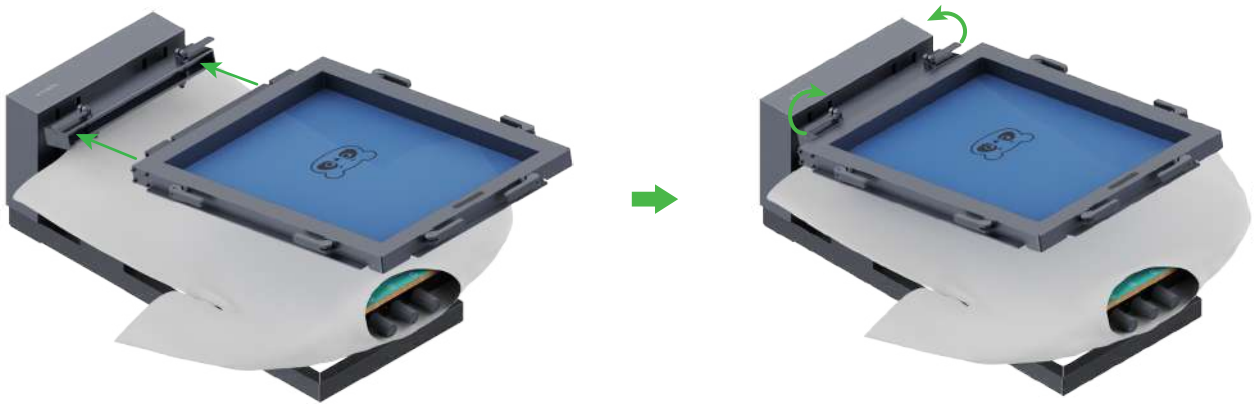
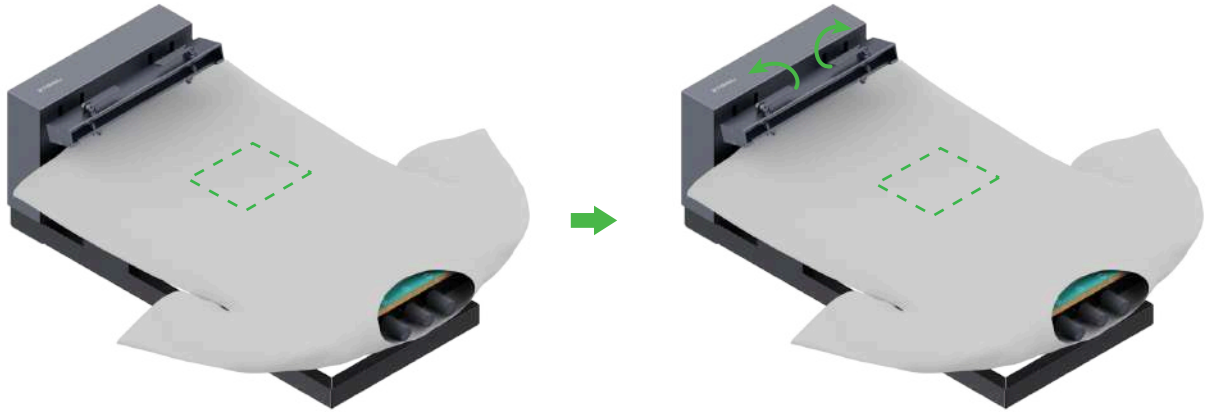

You can turn the screen position lock knob clockwise to lock the position of the screen for printing. Alternatively, you can press the frame on an edge and hold it down during printing.



Ensure that the ink is enough to cover the pattern.
When squeezing out the ink, slide the squeegee quickly to avoid transferring too much ink.

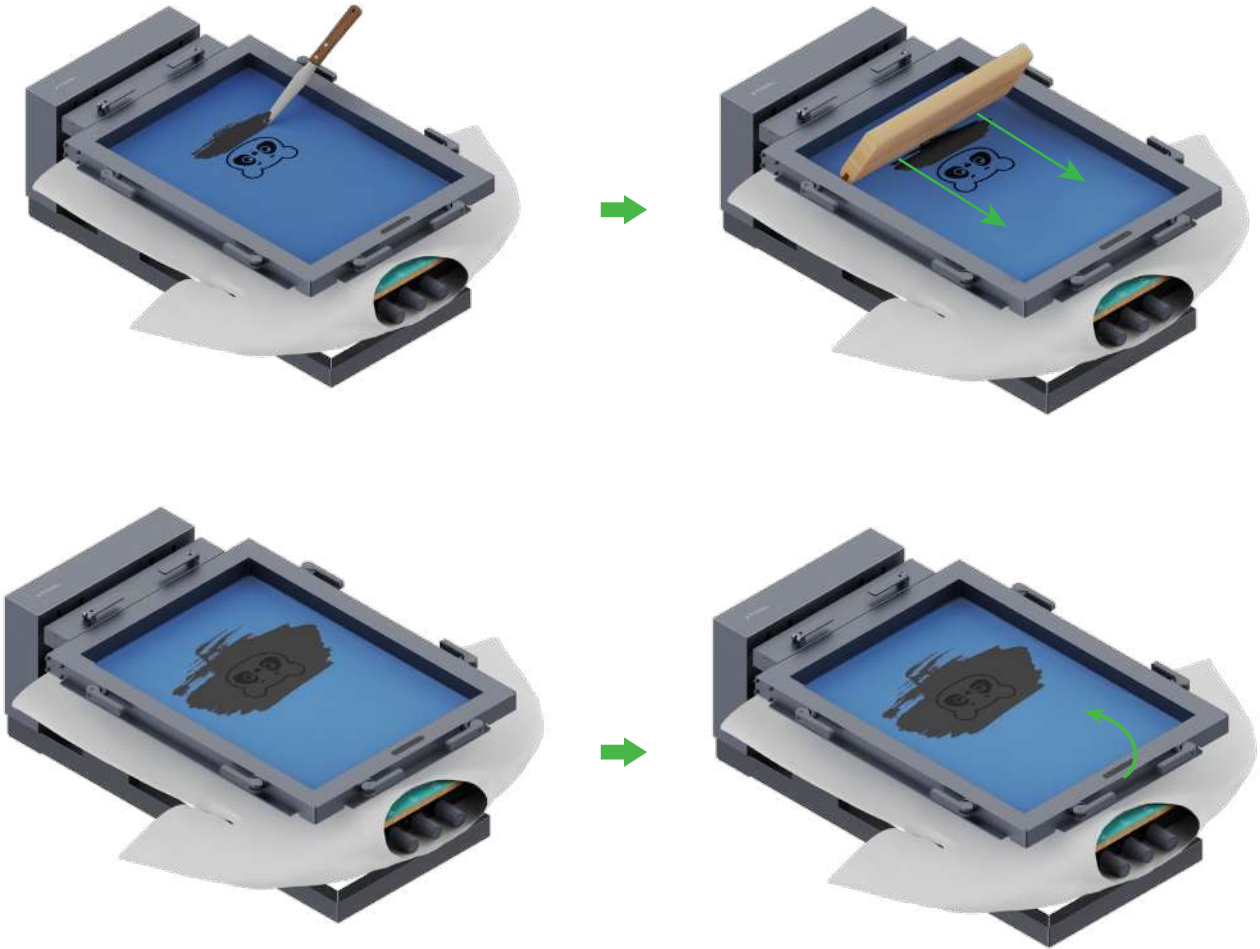

After printing, wait about 10 minutes for the ink to air-dry. If your material is a textile fabric, you are advised to wait 48 hours before you wash it.

Maintenance

After completing the printing, you can clean the screen and keep it for subsequent use. Clean it based on the type of ink you've used.

• Water-based ink

Rinse the screen to remove the ink. You can use a soft brush to remove the ink gently. If the ink is dry and hard to remove, use water or some non-corrosive detergent to clean it.

• Other ink

You can purchase other ink, including acrylic ink, plastisol ink, oil-based ink, and featured ink such as thermochromic ink, photochromic ink, and puff plastisol ink, at xtool.com. For more information about how to remove these kinds of ink from screens, visit support.xtool.com/article/1593.

Before using detergent or solvent to clean the screen, test it in a small area of the screen to see whether it damages the screen. After cleaning, rinse the screen to remove the remaining detergent or solvent, and then air-dry the screen or dry it with compressed air.

Warnings:

- Before you use any detergent or solvent, be sure to read its user manual carefully and follow all the safety instructions. Ensure that you use it in a well-ventilated place.
- Do not use a hard or sharp tool to scrape the ink from the screen, or damage may be caused to the screen.

After-sales services

For technical support, contact us at support@xtool.com.

For more information about after-sales services, visit support.xtool.com.

XTOOL